

QUALIFIED BY ROLLS-ROYCE UNDER LICENSING AGREEMENT

TRENT XWB SES

ENGINE TRANSPORTATION STAND

P/N: RRT105698 / CORE STAND
P/N: RRT057892-4 / FAN CASE STAND
P/N: RRT103183 / STORAGE CONTAINER

OFFICIAL
OEM
LICENSEE

- TRENT XWB ENGINE FOR A350 FAMILY
- 3 PRODUCTS: CORE STAND, FAN CASE STAND, STORAGE CONTAINER
- CORE STAND:
 - On-wing removal/installation of the Trent XWB 84/-97 Engine using the bootstrap adaptor
 - Storage of the complete Engine or Core configuration
 - Airfreight the complete engine or QECU in both the Antonov AN124 and the Airbus Beluga with an integral airfreight pallet
- ALL STANDS:
 - Transportation of an engine in a split configuration (B747F or B777F aircraft) by Road, Sea & Air
 - Fully shock attenuated to protect the engine during transportation
 - Can be lifted both empty and with the engine installed using either a forklift or crane with the appropriate tooling and capability





AOG - 24/7 HOTLINE: +1(802)4733341

DEDIENNE-AERO.COM | LEAPTOOLING.COM | NACELLETOOLING.COM  

DEDIENNE
AEROSPACE



TRENT XWB SES CORE STAND SPECIFICATIONS

	WEIGHT 8500 kg [18,750 lbs]
	DIMENSIONS 5640 x 2986 x 2550 mm [222 x 118 x 101 in]



Engine configurations used on the SES CORE STAND:



- Whole Engine configuration
- Quick Engine change unit Configuration
- Local Transportation
- Road Transportation





- Core Engine configuration
- Local Transportation
- Road Transportation
- Air Transportation

TRENT XWB SES ACCESSORIES FOR CORE STAND, FAN CASE STAND & STORAGE CONTAINER	
IMMOBILISER	RRT087465
CORE FAIRING ADAPTOR	RRT109747-2

RRT105698 / CORE STAND	
ACCESSORIES	P/N
MVP BAG WHOLE ENGINE	RRT096712
MVP BAG QECU	RRT096713
MVP BAG CORE ENGINE	RRT096711
HIGH DEMAND SPARE PARTS	
TOWBAR	
PALLET	
HEX HEAD BOLT	
SPRING ELEMENT	
SERVICES	P/N
PERIODIC RECERTIFICATION	PRRPANN2200084
SHOCK ABSORBER REPLACEMENT	PRRPREP2200022

TRENT XWB SES FAN CASE SPECIFICATIONS



	WEIGHT 7000 kg [15,450 lbs]
	DIMENSIONS 4978 x 5410 x 2284 mm [196 x 213 x 90 in]



- Used for the splitting operation between the core and the fan case of the **TRENT XWB**
- Allow Storage and Local-site movement of the fan case module of the **TRENT XWB - 84/-97 Engine**
- Allow the air transportation of the **Split Engine Fan case** configuration in a **B747F and B777F**
- Allow road transportation of a **TRENT XWB -84/-97 Engine Fan case** configuration **RRT057892**

RRT057892-4 / FAN CASE	
ACCESSORIES	P/N
MVP BAG	RRT063892
HIGH DEMAND SPARE PARTS	
SCREW	
PALLET	
CASTER	
ALLEN KEY	
SERVICES	P/N
PERIODIC RECERTIFICATION	PRRPANN2200085
SHOCK ABSORBER REPLACEMENT	PRRPREP2200022

TRENT XWB SES STORAGE CONTAINER SPECIFICATIONS

	WEIGHT 4057 kg [8,956 lbs]
	DIMENSIONS 2322 x 3062 x 2347 mm [91 x 121 x 92 in]

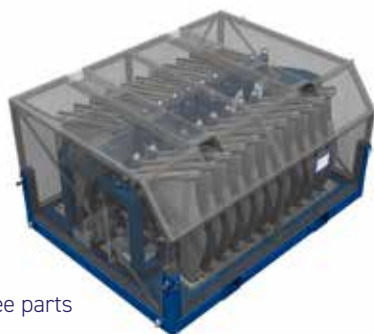

- The storage solution used to store all disassembled engine parts which are removed after the engine split process.
- The storage solution can be split into three parts
 - Upper container **RRT103434_D**
 - Lower container **RRT103435_F**
 - Air freight kit (optional) **RRT071407_A**

RRT103183 / STORAGE KIT	
ACCESSORIES	P/N
MVP BAG UPPER BAG	MK029-U
MVP BAG LOWER BAG	MK029-L
SERVICES	P/N
PERIODIC RECERTIFICATION	PRRPANN2200087